

INTRODUCTION OF THE FIRST YEAR PH.D. STUDENT

Michal Okál, Ing.

ÚSTAV KONSTRUOVÁNÍ
Fakulta strojního inženýrství
VUT v Brně

Brno, 30.9.2020



CONTENT

- Introduction of myself
- Hobbies and interest
- Education
- Bachelor thesis
- Diploma thesis
- Dissertation
- Teaching activities



INTRODUCTION OF MYSELF

- Hometown: Chropyně
- Population: 4900



(<https://mapy.cz>)



(<https://fatra.cz>)

INTRODUCTION OF MYSELF



(<https://google.cz/maps>)



Emil Filla
(<https://cs.wikipedia.org>)



Zámek Chropyně
(<https://google.cz/maps>)



Kostel sv. Jiljí
(<https://vychodni-morava.cz>)



(<https://muzeum-km.cz>)



Král Ječmínek
(<https://cs.wikipedia.org>)

INTRODUCTION OF MYSELF

- Chropyňská strojírna, a.s.
- Remiva, s.r.o.
- Fatra, a.s.
- Kalttech, s.r.o.



(<https://fatra.cz>)



(<http://chropynska.cz>)



(<https://kromerizsky.denik.cz>)



(<http://remivagroup.cz>)



(<http://chropynska.cz>)

HOBBIES

Sports

- MMA (mixed martial arts)
 - Kick-box
 - BJJ - brazilian jiu-jitsu
 - Wrestling
 - Physical strength
 - Good condition

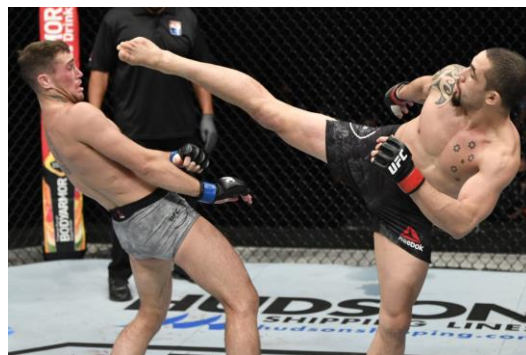

(<https://mmafighting.com>)

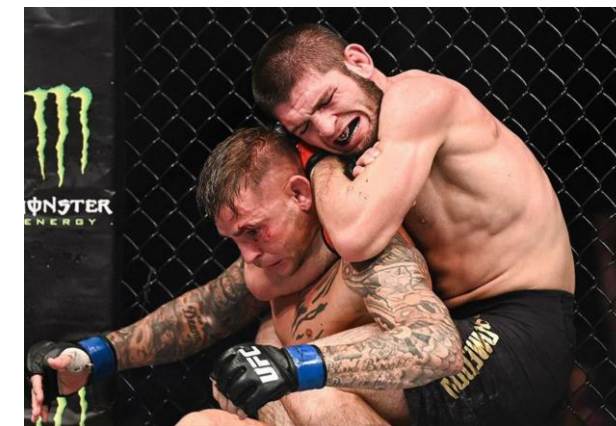

(<https://thegruelingtruth.com>)



(<https://thegruelingtruth.com>)



(<http://czechfighters.cz>)

EDUCATION

High school:

- Gymnázium Kojetín (2007-2015)

University:

▪ Bachelor's degree:

- BUT FME – Fundamentals of Mechanical Engineering (2015-2018)

▪ Master's degree:

- BUT FME – Mechanical Engineering (2018-2020)



(<https://.gkj.cz>)

BACHELOR THESIS

MODIFICATION OF THE TEST RIG FOR THE TESTING THE BEARINGS FOR THE SPACE APPLICATIONS

Supervisor: Ing. David Košťál, Ph.D.

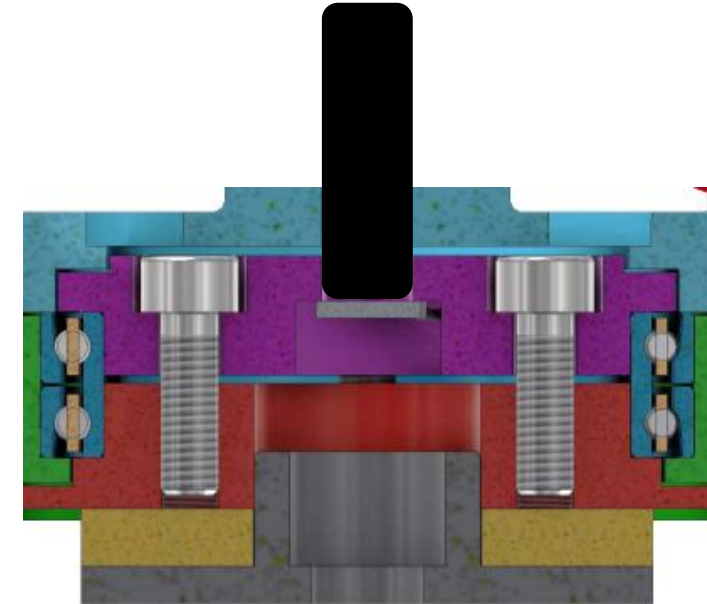
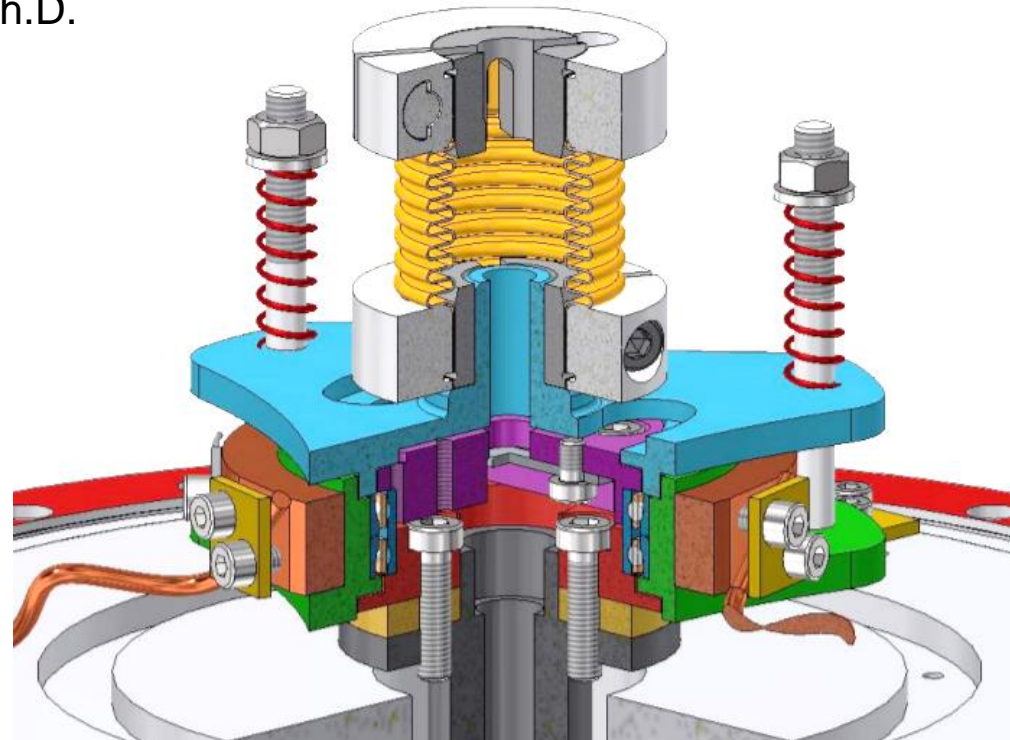
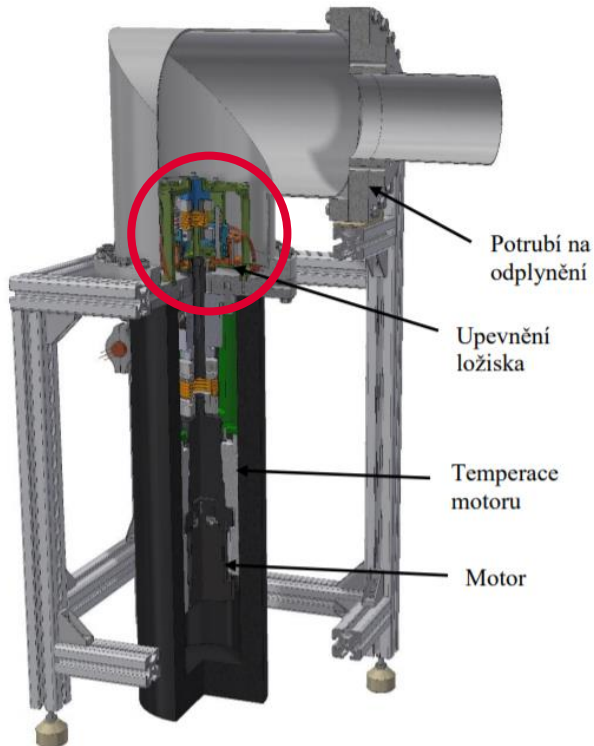

DIPLOMA THESIS

DESIGN OF THE TEST RIG FOR OBSERVATIONS OF THE LUBRICANT DISTRIBUTION IN THE ROLLING BEARING

Supervisor: Ing. David Košťál, Ph.D

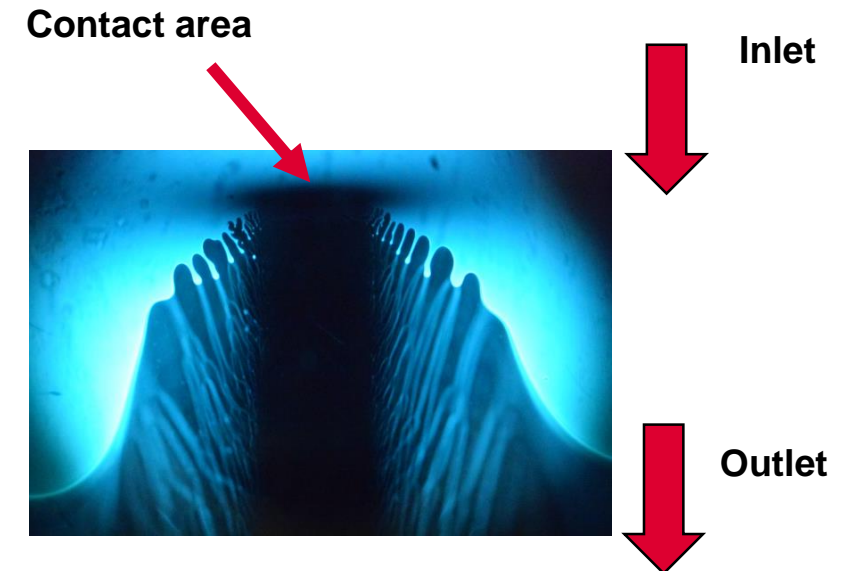
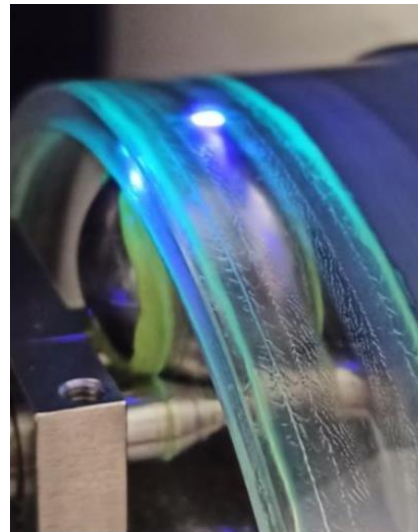
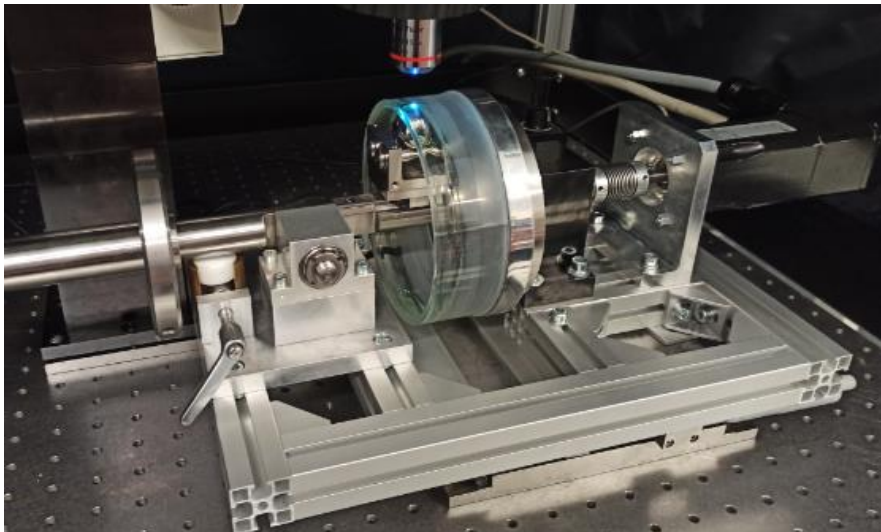

DISSERTATION THESIS

DEVELOPMENT OF BEARINGS WITH AUTOCIRCULATION OF PLASTIC LUBRICANT

Supervisor: prof. Ing. Ivan Křupka, Ph.D.

Supervisor specialist: Ing. David Košťál, Ph.D

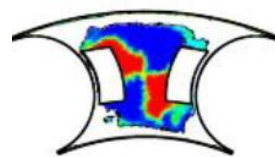
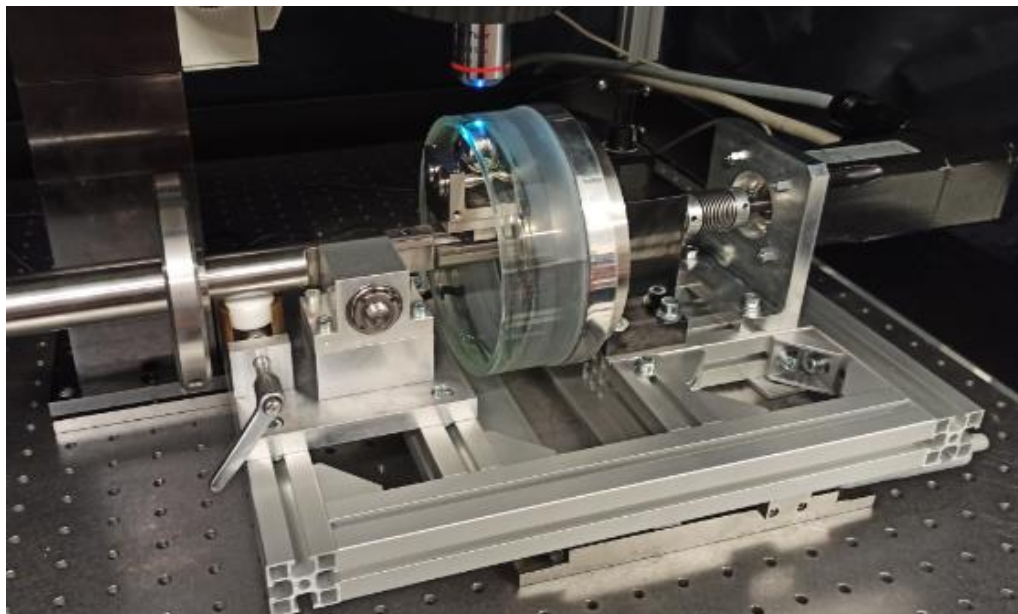

(Noda, 2020)

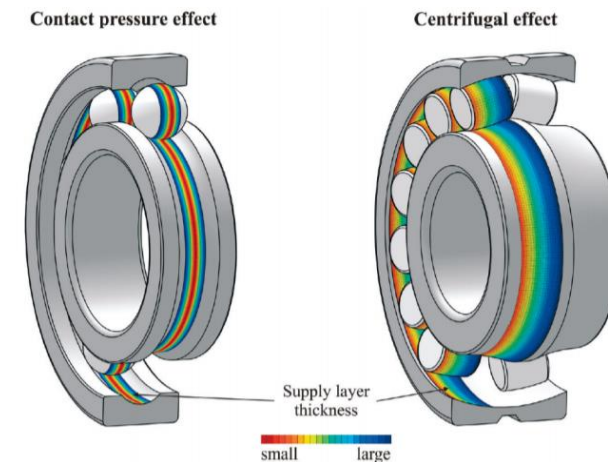
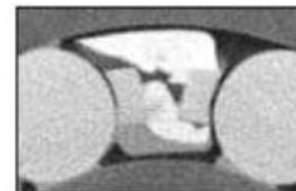

(Venner, 2012)

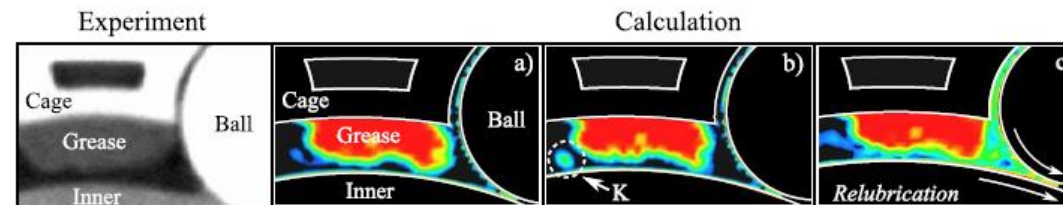

(Noda, 2020)

TEACHING ACTIVITIES

Teaching:

1K – Fundamentals of Mechanical Design

Learning:

- 9MOP – Methodologies of Scientific Work
- 9VPR – Research Project and Its Management
- 9AJ – English for Doctoral Degree Study
- 9EXT – Experimental Methods in Tribology
- 9EHD – Elastohydrodynamics

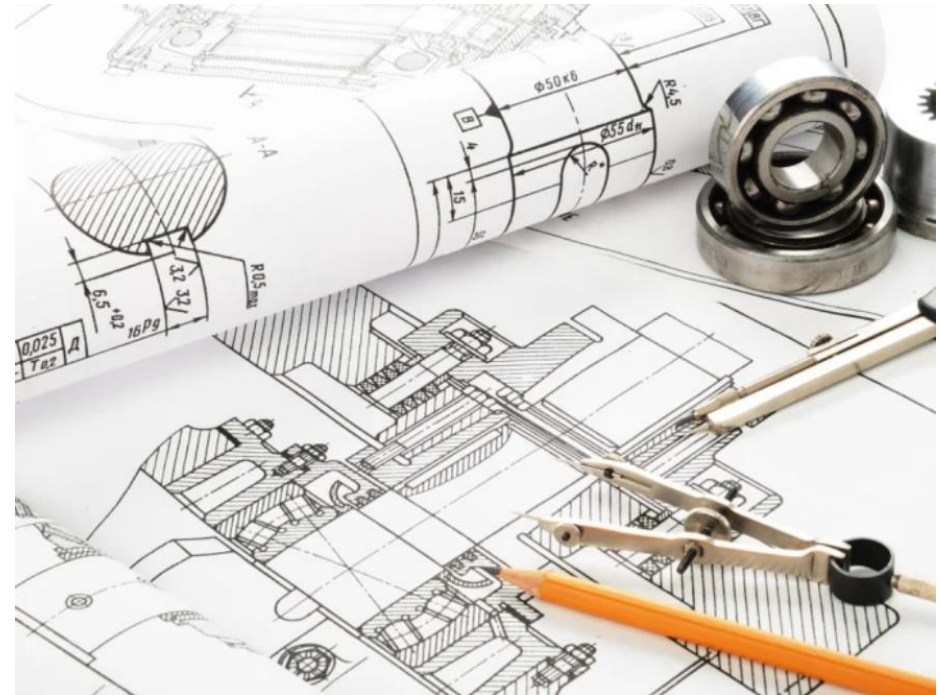

(<http://shardacad.blogspot.com>)

DĚKUJI VÁM ZA POZORNOST

Michal Okál, Ing.

Michal.Okal@vut.cz



ÚSTAV
KONSTRUOVÁNÍ

www.ustavkonstruovani.cz